

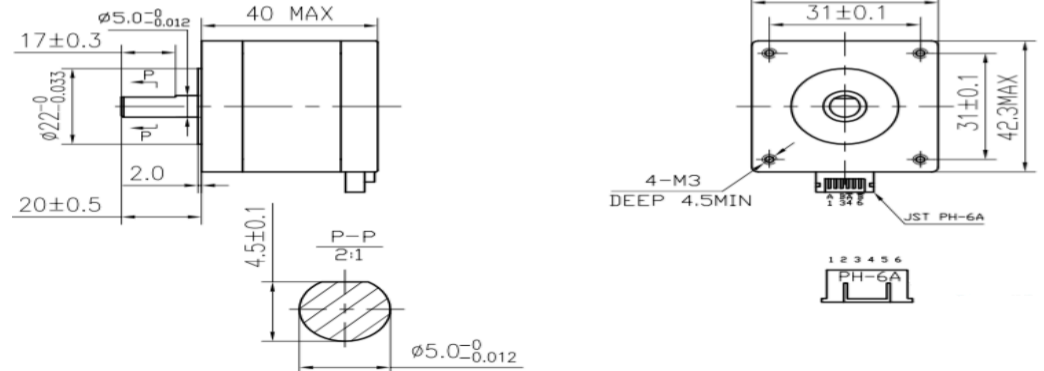

Spezifikationen / Specifications

Phase	2 Phase
Step Angle / Schrittwinkel	1.8° ± 5% / Step
Voltage / Nennspannung	2.55 V
Current / Nennstrom	1.7 A/Phase
Resistance / Widerstand	1.5 ± 10% Ω/Phase
Inductance / Induktanz	2.8± 20% mH/Phase
Holding Torque / Haltemoment	40 N.cm Min
Detent Torque / Rastmoment	2.8 N.cm Max
Insulation Class / Isolierungs Klasse	B
Lead Style / Kabel Art	AWG26 UL1007
Rotor Torque / Rotorträgheit	54 g.cm ²

Mechanische Abmessungen / Mechanical Dimensions



Verbindungen / Connections

Drehmomentkurve / Torque Curve

